

Multi Control Device TACT Switch™ 4-direction with Center-push Function (SMD & Snap-in Type)

SKQU Series

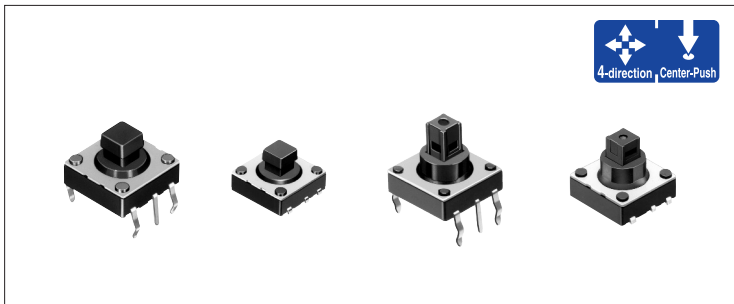

10×10mm size with sharp click feeling.



Multi Control Devices

Product Line

4-directional Type

Product No.	Operating force		Travel (mm)		Rating (max.)	Rating (min.)	Operating life (5mA 5V DC)	Initial contact resistance	Variety	Minimum order unit (pcs.)	Drawing No.
	4-direction	Center-push	4-direction	Center-push							
SKQUAAA010	1.57N	—	0.35	—	50mA 12V DC	10μA 1V DC	50,000cycles for each direction	500mΩ max.	Snap-in type	1,000	1
SKQUBAE010									Surface mount type	3,000	2

With Center-push Type

Product No.	Operating force		Travel (mm)		Rating (max.)	Rating (max.)	Operating life (5mA 5V DC)	Initial contact resistance	Variety	Minimum order unit (pcs.)	Drawing No.
	4-direction	Center-push	4-direction	Center-push							
SKQUCAA010	1.57N	3.14N	0.4	0.2	50mA 12V DC	10μA 1V DC	100,000cycles for each direction	500mΩ max.	Snap-in type	1,000	3
SKQUDBE010									Surface mount type	2,400	4

Variable Resistor Type

Switch Type

Packing Specifications

Taping

Unit:mm

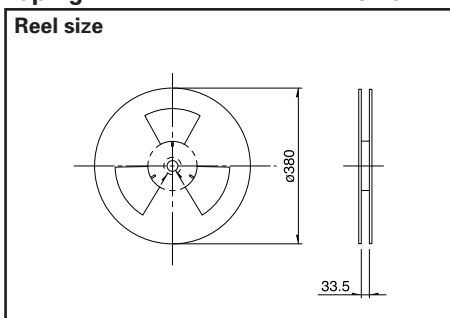

Series	Number of packages (pcs.)			Tape width (mm)	Export package measurements (mm)
	1 reel	1 case /Japan	1 case /export packing		
SKQUBA	750	3,000	3,000	32	401×401×214
SKQUDB	600	2,400	2,400		

Bulk

Product No.	Number of packages (pcs.)		Export package measurements (mm)
	1 case /Japan	1 case/export packing	
SKQUAA	4,000	12,000	309×476×347
SKQUCA			

Notes

1. For SKQUAA, and SKQUBA models, the 4-directional operating force and travel are measured 0.9mm below the top of the stem.
2. For SKQUCA models, the 4-directional operating force and travel are measured 2.9mm below the top of the stem.
3. For SKQUDB models, the 4-directional operating force and travel are measured 1.5mm below the top of the stem.
4. Please place purchase orders for taping products per minimum package units (1 reel or 1 case).







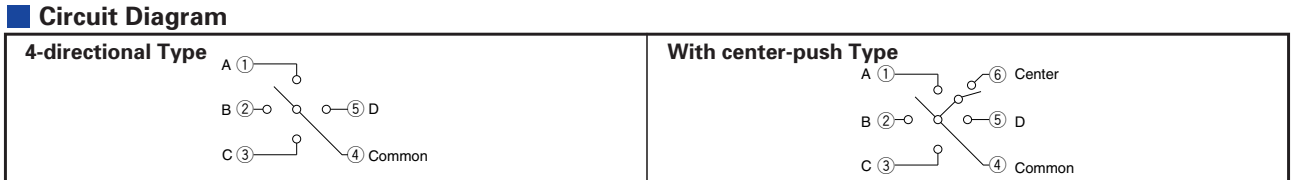

Refer to P.495 for soldering conditions.

Dimensions (4-directional Type)			Unit:mm
No.	Photo	Style	PC board mounting hole dimensions (Viewed from switch mounting face)
1			
2			
3			
4			

Note
 Thickness of the printed wiring boards in Figures 1 and 3 is 1.6mm.

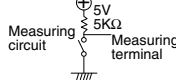

List of Varieties

Items		Series	Switch type					
		SKQU			SSAF	SRBE	SLLB	SLLB5 Small type
		SKQUAA/SKQUBA	SKQUCA	SKQUDB				
Photo								
Function								
Dimensions (typical value) (mm)	W	10			10.85	8.05	11.8	9.5
	D					11	11.4	8.8
	H	7.1	10	8.6	3	3.17	3	2.2
Outlined specifications	Number of operating shafts	Single-shaft						
	Shaft material	Resin						
	Directional resolution	4-direction			8-contact	—	2-direction	
	Directional operating feeling	With			Without	With	Without	
	Lever return mechanism	With			Without	Without	With	
	Center-push switch	With/Without			With		With/Without	With
Encoder	Without				With		Without	
Operating temperature range		-30°C to +85°C			-10°C to +60°C			
Automotive use		—						
Rating (max.) (Resistive load)		50mA 12V DC			20mA 5V DC	1mA 5V DC	10mA 5V DC	
Electrical performance	Output voltage	—			1V max. at 1mA 5V DC (Resistive load)			
	Directional resolution	4-direction			8-contact	—	2-direction	
	Insulation resistance	100MΩ min. 100V DC			10MΩ min. 100V DC	50MΩ min. 50V DC	100MΩ min. 100V DC	
	Voltage proof	250V AC for 1min.			100V AC for 1min.	50V AC for 1min.	100V AC for 1min.	
	Directional operating force	1.57 ^{+0.49} _{-0.59} N	1.57 ^{+0.39} _{-0.69} N		0.5N ^{+0.5} _{-0.95} N	—	0.65±0.3N	
Mechanical performance	Push operating force	—	3.14±0.59N		2.5 ^{+0.7} _{-0.6} N	3.5±1.5N	2±1N	2.5±1N
	Encoder detent torque	—				3±2mN·m		—
	Terminal strength	—						3N for 1min.
	Actuator strength	Pushing direction	—			50N		
Operating direction		—			50N	—	10N	
Endurance	Vibration	10 to 55 to 10Hz/min., the amplitude is 1.5mm for all the frequencies, in the 3 direction of X, Y and Z for 2 hours respectively						
	Operating life without load	—						100,000cycles
	Operating life with load (at rated load)	—						
Environmental performance	Cold	-30±2°C for 96h			-40±2°C for 96h		-20±2°C for 96h	
	Dry heat	80±2°C for 96h			85±2°C for 96h			
	Damp heat	60±2°C, 90 to 95%RH for 96h			40±2°C, 90 to 95%RH for 96h			
Soldering	Manual soldering	350°C max. 3s max.			350±10°C 4 ⁺ 1s	350±5°C 3s max.		
	Dip soldering	260°C max. 5s max. (SKQUAA,CA)			—			
	Reflow soldering	Please see P.495 (SKQUBA,DB)			Please see P.495			
Page		485			487	489	491	493

Multi Control Devices

Variable Resistor Type

Switch Type

- Switch Type Multi Control Devices Soldering Conditions495
- Switch Type Multi Control Devices Cautions496

Soldering Conditions

Example of Reflow Soldering Condition

1. Heating method: Double heating method with infrared heater.
2. Temperature measurement: Thermocouple 0.1 to 0.2 ϕ CA (K) or CC (T) at solder joints copper foil surface). A heat resistive tape should be used to fix thermocouple.
3. Temperature profile

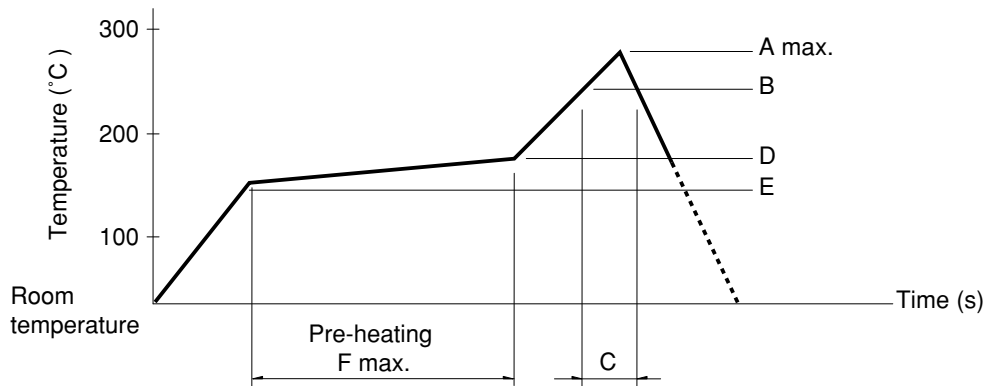

Series (Reflow type)	A (°C) 3s max.	B (°C)	C (s)	D (°C)	E (°C)	F (s)
RKJXS	260	230	40	150	150	120
SLLB, SLLB5	240		20			
SKRV/SKRH/SKQUBA,DB/SSAF/SRBE	260		40	180		

Notes

1. The above temperature shall be measured on the mounting surface of a PC board. There are cases where the PC board's temperature greatly differs from that of the switch, depending on the material, size thickness of PC boards and others. The above-stated conditions shall also apply to switch surface temperatures.
2. Soldering conditions differ depending on reflow soldering machines. Prior verification of soldering condition is highly recommended.

Multi Control Devices

Variable Resistor Type

Switch Type